

3 A low-drop, adjustable positive voltage regulator

Features

- Typical dropout 1.3 V (at 3 A)
- Three terminal adjustable output voltage
- Guaranteed output current up to 3 A
- Output tolerance $\pm 2\%$ at 25 °C and $\pm 3\%$ in full temperature range
- Internal power and thermal limit
- Wide operating temperature range -40 °C to 125 °C
- Package available: DPAK
- Pinout compatibility with standard adjustable VREG

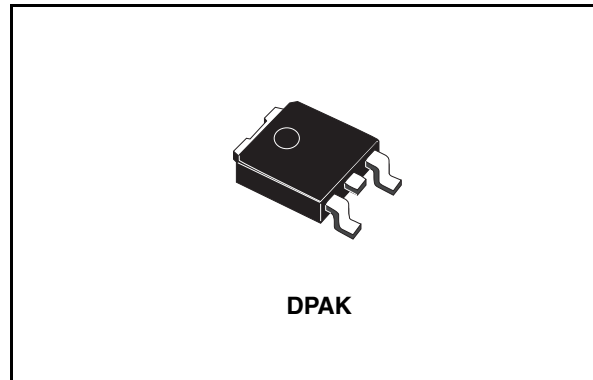

Description

The LD1085C is a low drop voltage regulator able to provide up to 3 A of output current. Dropout is guaranteed at a maximum of 1.5 V at the maximum output current, decreasing at lower loads. The LD1085C is pin to pin compatible with the older 3-terminal adjustable regulators, but has better performances in term of drop and output tolerance.

A 2.85 V output version is suitable for SCSI-2 active termination. Unlike PNP regulators, where a part of the output current is wasted as quiescent current, the LD1085C quiescent current flows into the load, so increase efficiency. Only a 10 μ F minimum capacitor is need for stability.

The device is supplied in DPAK. On chip trimming allows the regulator to reach a very tight output voltage tolerance, within $\pm 2\%$ at 25 °C.

Table 1. Device summary

Order codes	Packages
LD1085CDT-R	DPAK (tape and reel)

Contents

1	Diagram	3
2	Pin configuration	4
3	Maximum ratings	5
4	Schematic application	6
5	Electrical characteristics	7
6	Typical application	8
7	Package mechanical data	12
8	Revision history	15

1 Diagram

Figure 1. Schematic diagram

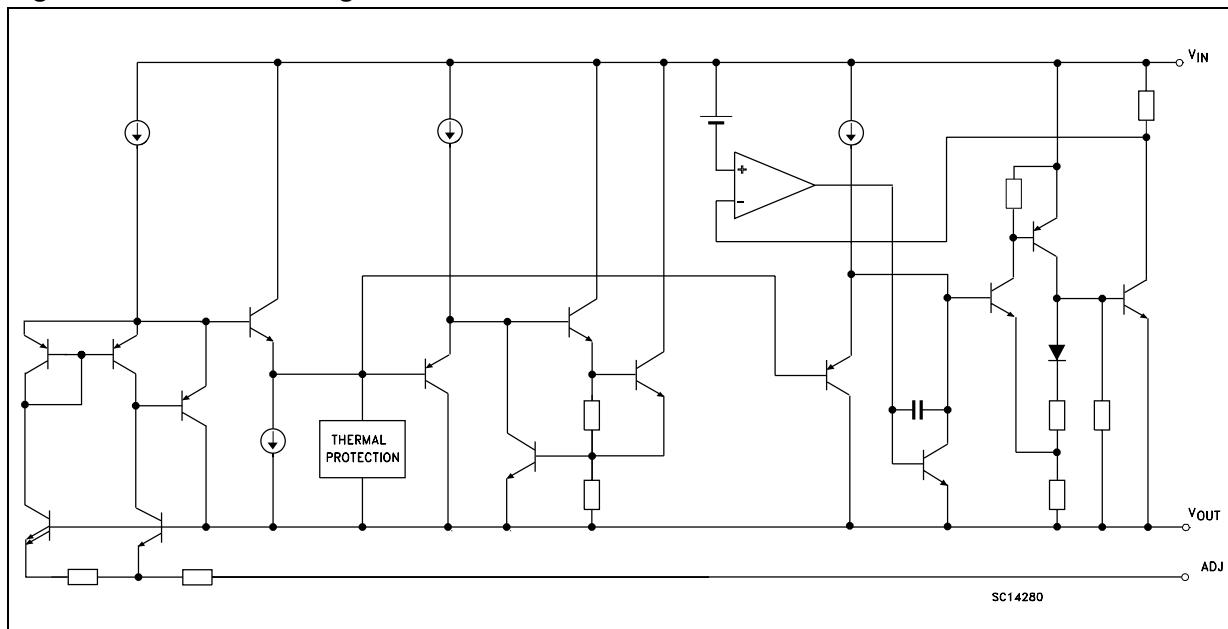

2 Pin configuration

Figure 2. Pin connections (top view)

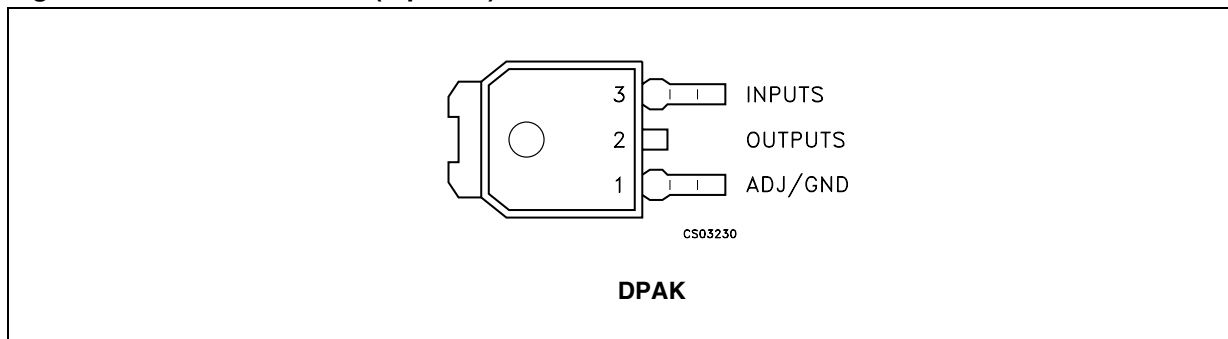

3 Maximum ratings

Table 2. Absolute maximum ratings

Symbol	Parameter	Value	Unit
V_I	DC input voltage	30	V
I_O	Output current	Internally limited	
P_D	Power dissipation	Internally limited	
T_{STG}	Storage temperature range	-55 to +150	°C
T_{OP}	Operating junction temperature range	-40 to +125	°C

Note: Absolute maximum ratings are those values beyond which damage to the device may occur. Functional operation under these condition is not implied.

Table 3. Thermal data

Symbol	Parameter	DPAK	Unit
R_{thJC}	Thermal resistance junction-case	3	°C/W
R_{thJA}	Thermal resistance junction-ambient	62.5	°C/W

4 Schematic application

Figure 3. Application circuit

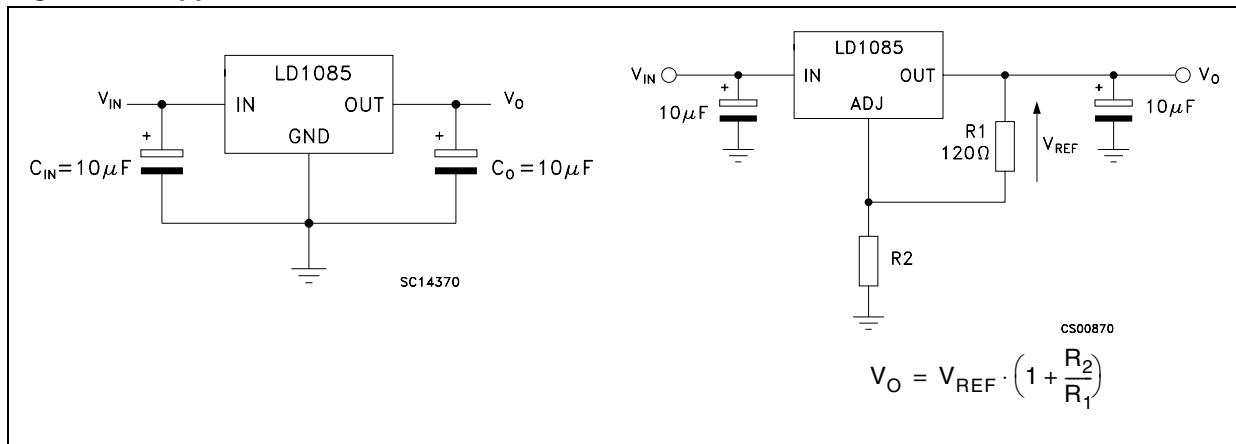

5 Electrical characteristics

Table 4. Electrical characteristics of LD1085CDT
($V_I = 4.25\text{ V}$, $C_I = C_O = 10\ \mu\text{F}$, $T_A = -40\text{ to }125\text{ }^\circ\text{C}$, unless otherwise specified).

Symbol	Parameter	Test condition	Min.	Typ.	Max.	Unit
V_O	Output voltage ⁽¹⁾	$I_O = 10\text{mA}$, $T_J = 25^\circ\text{C}$	1.225	1.25	1.275	V
		$I_O = 10\text{mA to }3\text{A}$, $V_I = 2.85\text{ to }30\text{V}$ ⁽¹⁾	1.213	1.25	1.288	V
ΔV_O	Line regulation	$I_O = 10\text{mA}$, $V_I = 2.85\text{ to }16.5\text{V}$, $T_J = 25^\circ\text{C}$		0.015	0.2	%
		$I_O = 10\text{mA}$, $V_I = 2.85\text{ to }16.5\text{V}$		0.035	0.2	%
ΔV_O	Load regulation	$I_O = 10\text{mA to }5\text{A}$, $T_J = 25^\circ\text{C}$		0.1	0.3	%
		$I_O = 0\text{ to }5\text{A}$		0.2	0.4	%
V_d	Dropout voltage	$I_O = 5\text{A}$		1.3	1.5	V
$I_{O(\text{min})}$	Minimum load current	$V_I = 30\text{V}$		3	10	mA
I_{sc}	Short circuit current	$V_I - V_O = 5\text{V}$	3.2	4.5		A
		$V_I - V_O = 25\text{V}$	0.2	0.5		A
	Thermal regulation	$T_A = 25^\circ\text{C}$, 30ms pulse		0.003	0.015	%/W
SVR	Supply voltage rejection	$f = 120\text{ Hz}$, $C_O = 25\ \mu\text{F}$, $C_{\text{ADJ}} = 25\ \mu\text{F}$, $I_O = 3\text{A}$, $V_I = 6.25 \pm 3\text{V}$	60	75		dB
I_{ADJ}	Adjust pin current	$V_I = 4.25\text{V}$, $I_O = 10\text{ mA}$		55	120	μA
ΔI_{ADJ}	Adjust pin current change	$I_O = 10\text{mA to }3\text{A}$, $V_I = 2.75\text{ to }16.5\text{V}$ ⁽¹⁾		0.2	5	μA
eN	RMS output noise voltage (% of V_O)	$T_A = 25^\circ\text{C}$, $f = 10\text{Hz to }10\text{kHz}$		0.003		%
S	Temperature stability			0.5		%
S	Long term stability	$T_A = 125^\circ\text{C}$, 1000Hrs		0.5		%

1. See short-circuit current curve for available output current at fixed dropout.

6 Typical application

(Unless otherwise specified $T_J = 25\text{ }^\circ\text{C}$, $C_I = C_O = 10\text{ }\mu\text{F}$)

Figure 4. Output voltage vs temperature

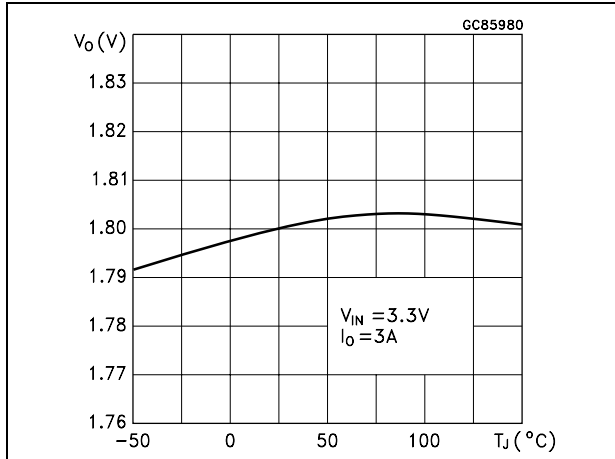

Figure 5. Output voltage vs temperature

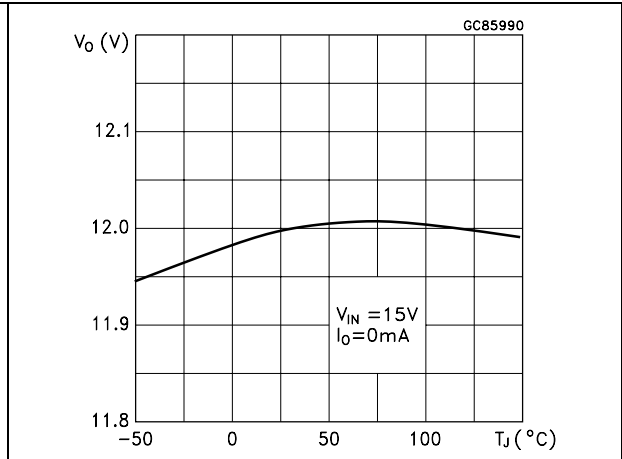

Figure 6. Output voltage vs temperature

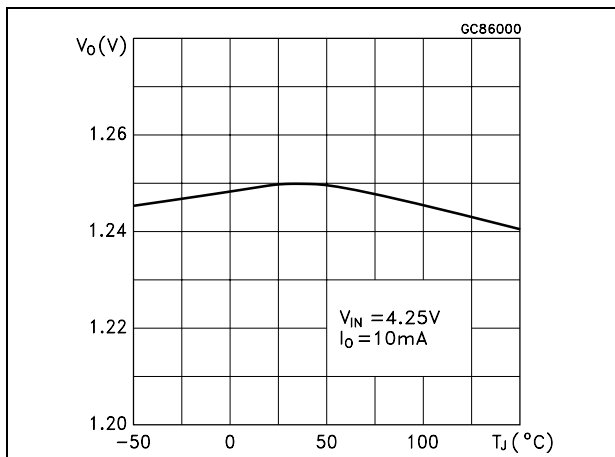

Figure 7. Short circuit current vs dropout voltage

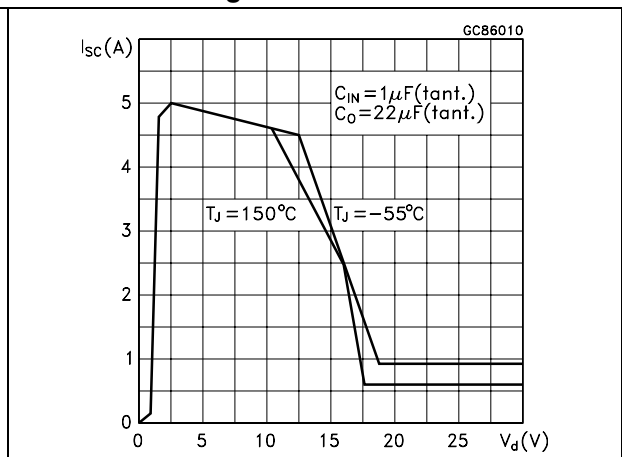

Figure 8. Line regulation vs temperature

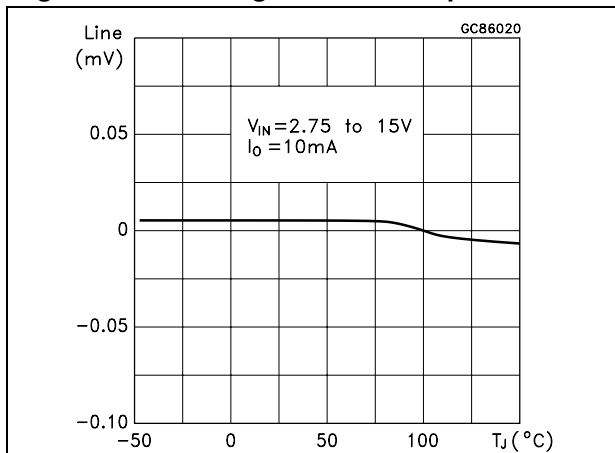

Figure 9. Load regulation vs temperature

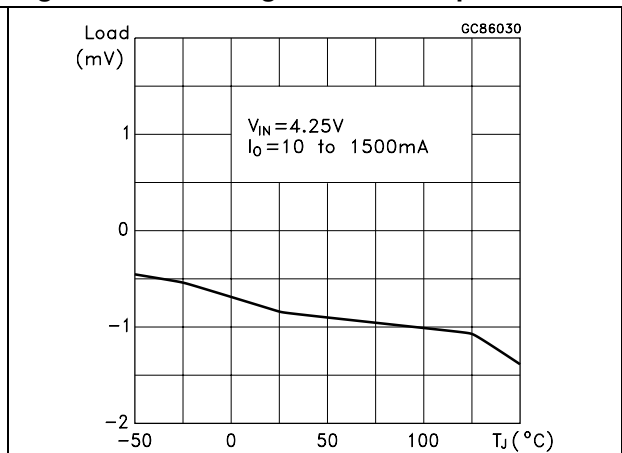

Figure 10. Dropout voltage vs temperature

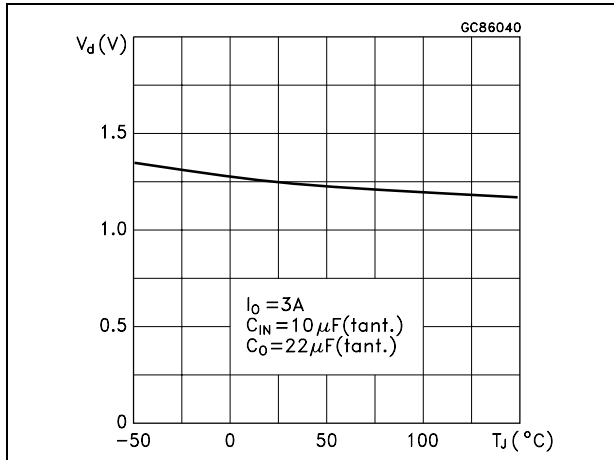

Figure 11. Dropout voltage vs output current

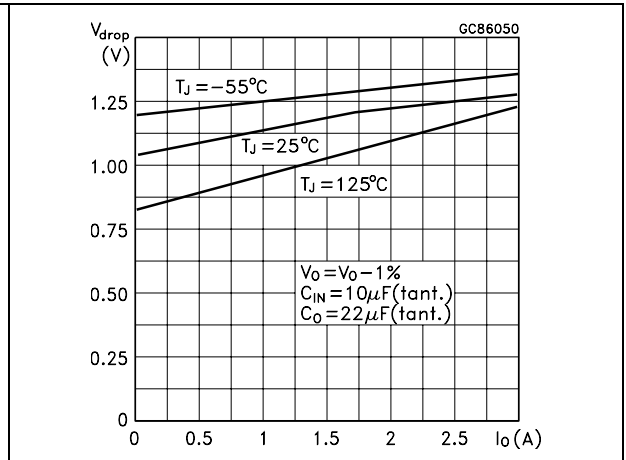

Figure 12. Adjust pin current vs temperature

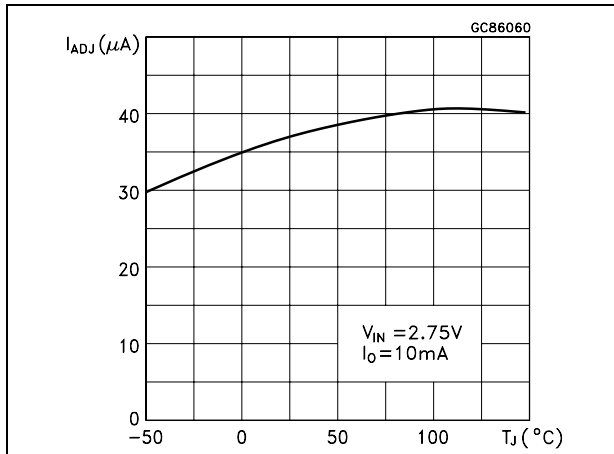

Figure 13. Quiescent current vs temperature

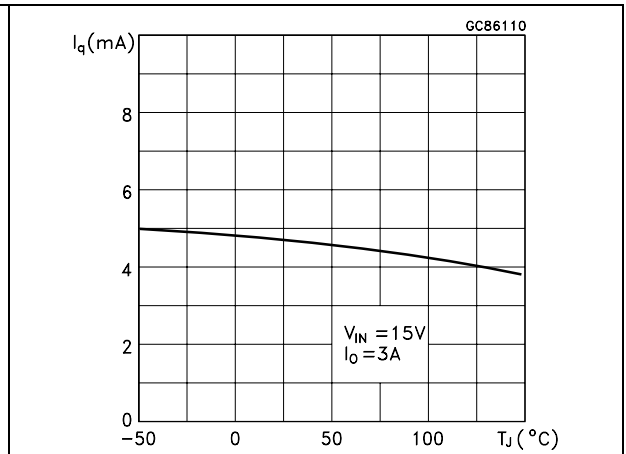

Figure 14. Line regulation vs temperature

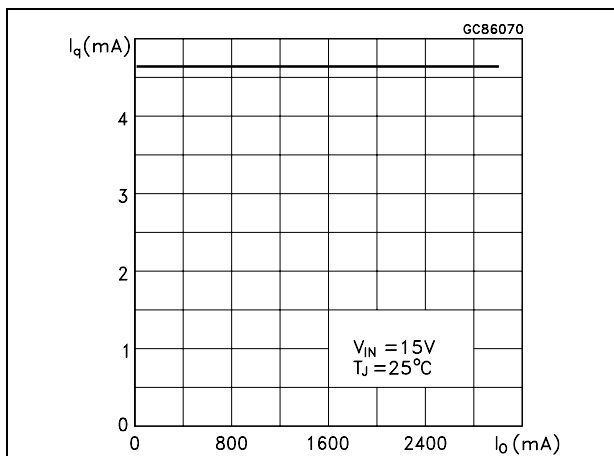

Figure 15. Supply voltage rejection vs output current

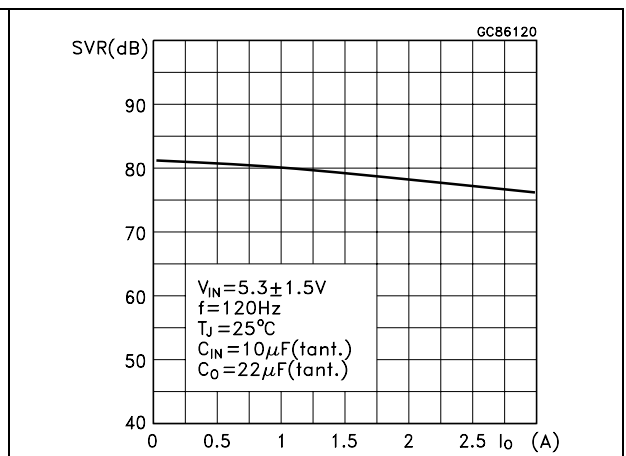

Figure 16. Supply voltage rejection vs frequency

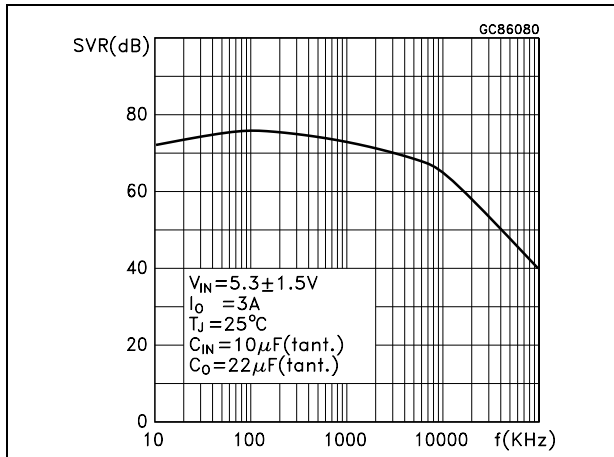

Figure 17. Supply voltage rejection vs temperature

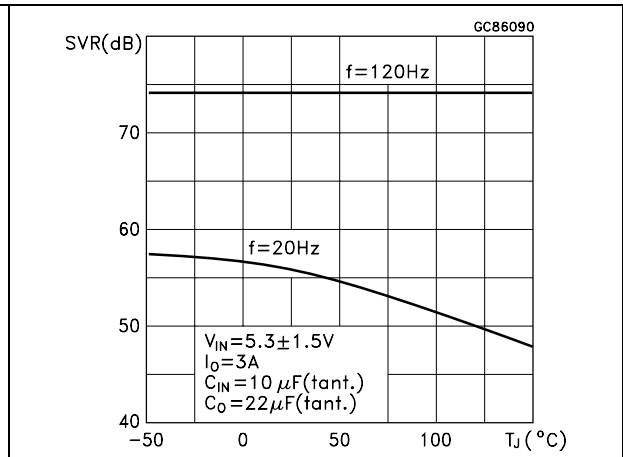

Figure 18. Minimum load current vs temperature

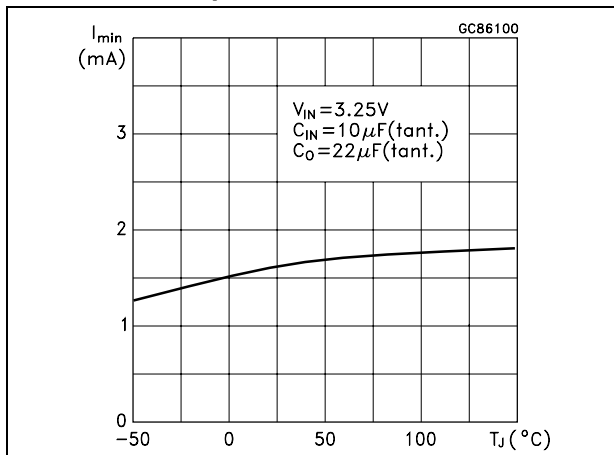

Figure 19. Stability

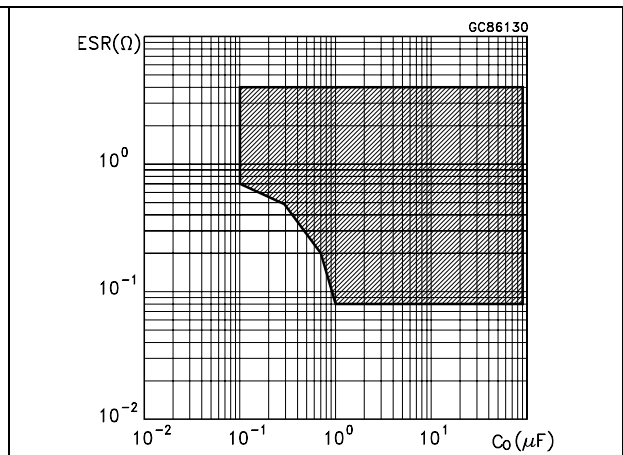

Figure 20. Stability

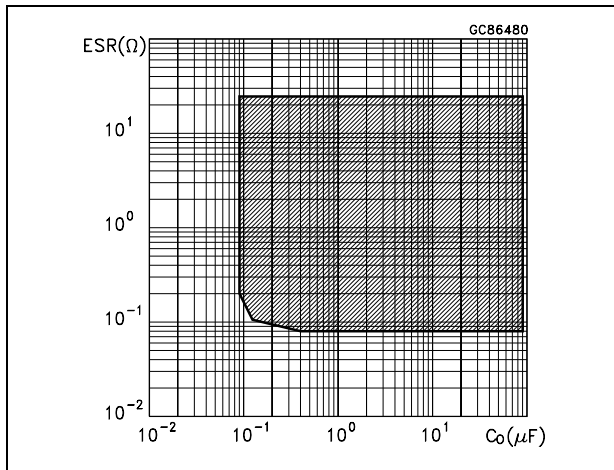

Figure 21. Line transient

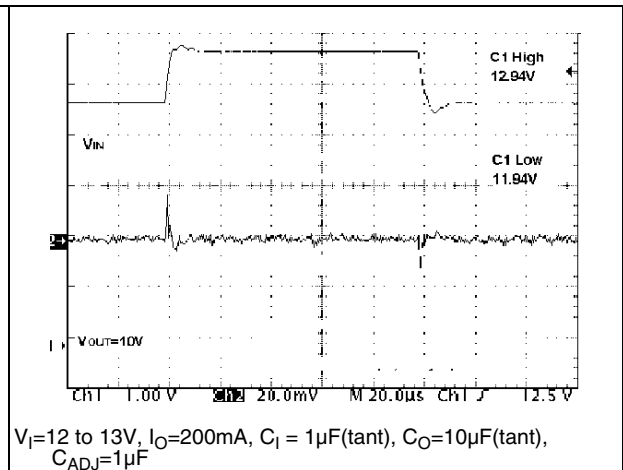

Figure 22. Line transient

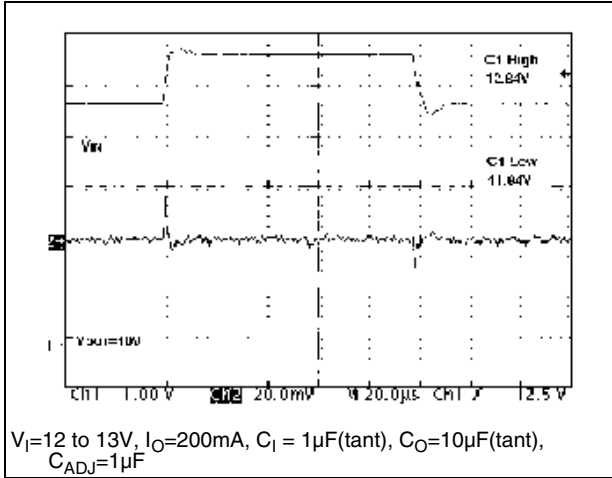

Figure 23. Load transient

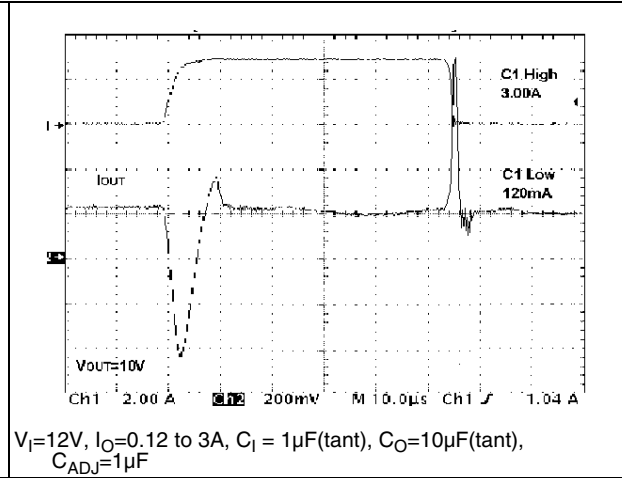
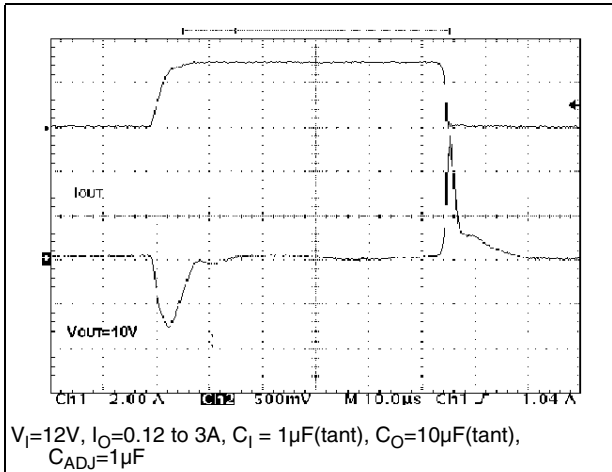

Figure 24. Load transient



7 Package mechanical data

In order to meet environmental requirements, ST offers these devices in ECOPACK® packages. These packages have a lead-free second level interconnect. The category of second Level Interconnect is marked on the package and on the inner box label, in compliance with JEDEC Standard JESD97. The maximum ratings related to soldering conditions are also marked on the inner box label. ECOPACK is an ST trademark. ECOPACK specifications are available at: www.st.com.

DPAK mechanical data

Dim.	mm.			inch.		
	Min.	Typ.	Max.	Min.	Typ.	Max.
A	2.2		2.4	0.086		0.094
A1	0.9		1.1	0.035		0.043
A2	0.03		0.23	0.001		0.009
B	0.64		0.9	0.025		0.035
b4	5.2		5.4	0.204		0.212
C	0.45		0.6	0.017		0.023
C2	0.48		0.6	0.019		0.023
D	6		6.2	0.236		0.244
D1		5.1			0.200	
E	6.4		6.6	0.252		0.260
E1		4.7			0.185	
e		2.28			0.090	
e1	4.4		4.6	0.173		0.181
H	9.35		10.1	0.368		0.397
L	1			0.039		
(L1)		2.8			0.110	
L2		0.8			0.031	
L4	0.6		1	0.023		0.039
R		0.2			0.008	
V2	0°		8°	0°		8°

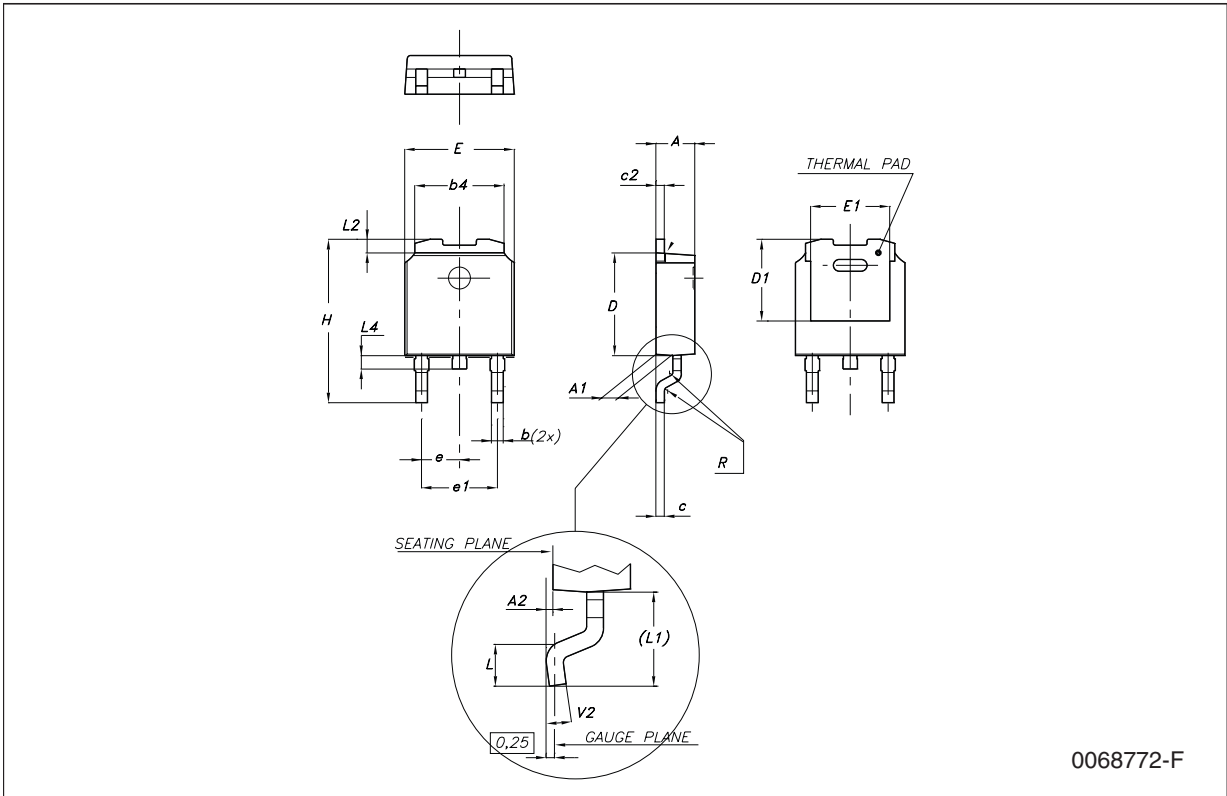

0068772-F

Tape & reel DPAK-PPAK mechanical data

Dim.	mm.			inch.		
	Min.	Typ.	Max.	Min.	Typ.	Max.
A			330			12.992
C	12.8	13.0	13.2	0.504	0.512	0.519
D	20.2			0.795		
N	60			2.362		
T			22.4			0.882
Ao	6.80	6.90	7.00	0.268	0.272	0.276
Bo	10.40	10.50	10.60	0.409	0.413	0.417
Ko	2.55	2.65	2.75	0.100	0.104	0.105
Po	3.9	4.0	4.1	0.153	0.157	0.161
P	7.9	8.0	8.1	0.311	0.315	0.319

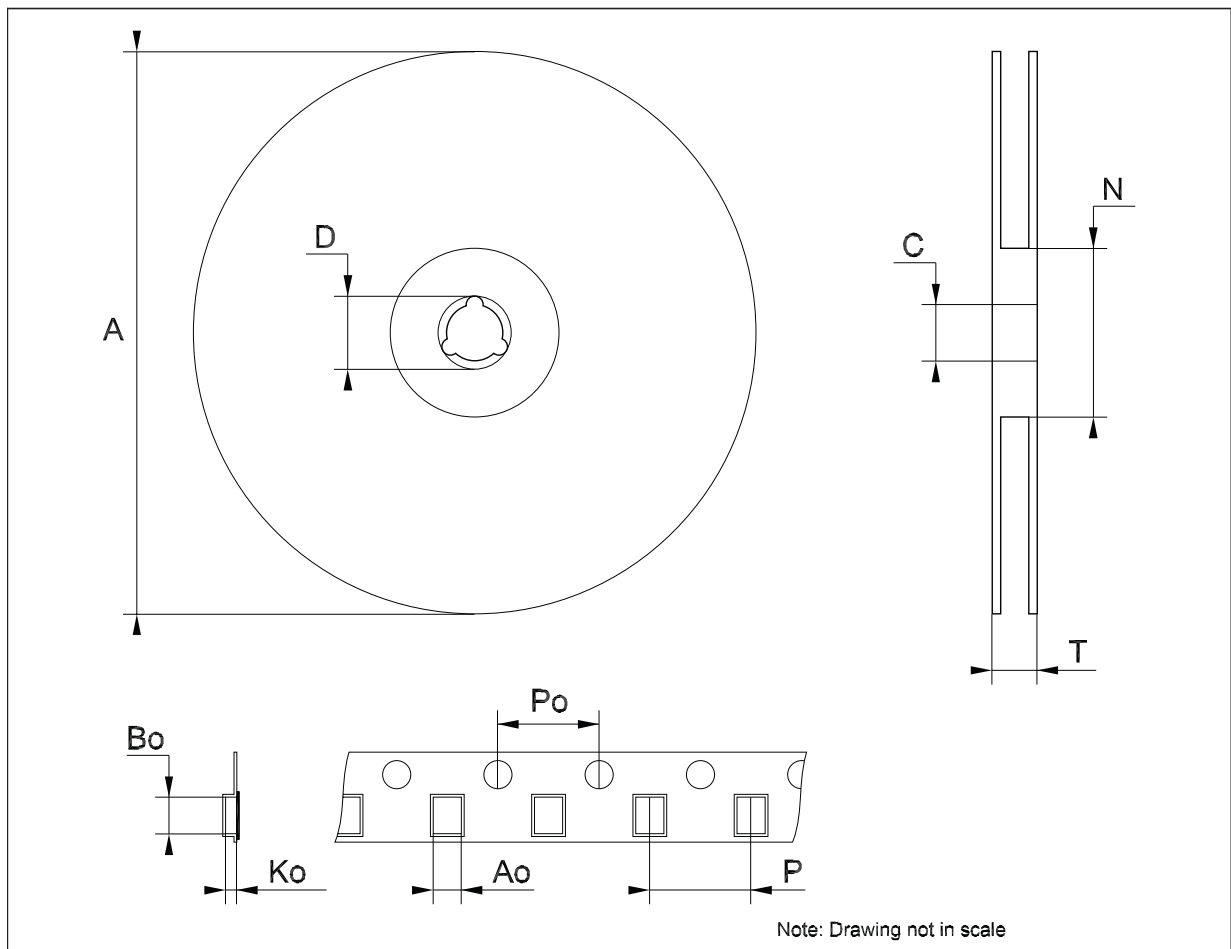

8 Revision history

Table 5. Document revision history

Date	Revision	Changes
07-Oct-2004	6	Mistake in Table 1.
03-Jul-2007	7	Order codes updated.
09-Apr-2008	8	Modified: Table 1 on page 1 .

Please Read Carefully:

Information in this document is provided solely in connection with ST products. STMicroelectronics NV and its subsidiaries ("ST") reserve the right to make changes, corrections, modifications or improvements, to this document, and the products and services described herein at any time, without notice.

All ST products are sold pursuant to ST's terms and conditions of sale.

Purchasers are solely responsible for the choice, selection and use of the ST products and services described herein, and ST assumes no liability whatsoever relating to the choice, selection or use of the ST products and services described herein.

No license, express or implied, by estoppel or otherwise, to any intellectual property rights is granted under this document. If any part of this document refers to any third party products or services it shall not be deemed a license grant by ST for the use of such third party products or services, or any intellectual property contained therein or considered as a warranty covering the use in any manner whatsoever of such third party products or services or any intellectual property contained therein.

UNLESS OTHERWISE SET FORTH IN ST'S TERMS AND CONDITIONS OF SALE ST DISCLAIMS ANY EXPRESS OR IMPLIED WARRANTY WITH RESPECT TO THE USE AND/OR SALE OF ST PRODUCTS INCLUDING WITHOUT LIMITATION IMPLIED WARRANTIES OF MERCHANTABILITY, FITNESS FOR A PARTICULAR PURPOSE (AND THEIR EQUIVALENTS UNDER THE LAWS OF ANY JURISDICTION), OR INFRINGEMENT OF ANY PATENT, COPYRIGHT OR OTHER INTELLECTUAL PROPERTY RIGHT.

UNLESS EXPRESSLY APPROVED IN WRITING BY AN AUTHORIZED ST REPRESENTATIVE, ST PRODUCTS ARE NOT RECOMMENDED, AUTHORIZED OR WARRANTED FOR USE IN MILITARY, AIR CRAFT, SPACE, LIFE SAVING, OR LIFE SUSTAINING APPLICATIONS, NOR IN PRODUCTS OR SYSTEMS WHERE FAILURE OR MALFUNCTION MAY RESULT IN PERSONAL INJURY, DEATH, OR SEVERE PROPERTY OR ENVIRONMENTAL DAMAGE. ST PRODUCTS WHICH ARE NOT SPECIFIED AS "AUTOMOTIVE GRADE" MAY ONLY BE USED IN AUTOMOTIVE APPLICATIONS AT USER'S OWN RISK.

Resale of ST products with provisions different from the statements and/or technical features set forth in this document shall immediately void any warranty granted by ST for the ST product or service described herein and shall not create or extend in any manner whatsoever, any liability of ST.

ST and the ST logo are trademarks or registered trademarks of ST in various countries.

Information in this document supersedes and replaces all information previously supplied.

The ST logo is a registered trademark of STMicroelectronics. All other names are the property of their respective owners.

© 2008 STMicroelectronics - All rights reserved

STMicroelectronics group of companies

Australia - Belgium - Brazil - Canada - China - Czech Republic - Finland - France - Germany - Hong Kong - India - Israel - Italy - Japan - Malaysia - Malta - Morocco - Singapore - Spain - Sweden - Switzerland - United Kingdom - United States of America

www.st.com